



A Quantitative Study of Growth and Production of Unionid Mussels in the River Thames at Reading

Christina L. Negus

The Journal of Animal Ecology, Vol. 35, No. 3. (Oct., 1966), pp. 513-532.

Stable URL:

<http://links.jstor.org/sici?sici=0021-8790%28196610%2935%3A3%3C513%3AAOSOGA%3E2.0.CO%3B2-I>

The Journal of Animal Ecology is currently published by British Ecological Society.

Your use of the JSTOR archive indicates your acceptance of JSTOR's Terms and Conditions of Use, available at <http://www.jstor.org/about/terms.html>. JSTOR's Terms and Conditions of Use provides, in part, that unless you have obtained prior permission, you may not download an entire issue of a journal or multiple copies of articles, and you may use content in the JSTOR archive only for your personal, non-commercial use.

Please contact the publisher regarding any further use of this work. Publisher contact information may be obtained at <http://www.jstor.org/journals/briteco.html>.

Each copy of any part of a JSTOR transmission must contain the same copyright notice that appears on the screen or printed page of such transmission.

The JSTOR Archive is a trusted digital repository providing for long-term preservation and access to leading academic journals and scholarly literature from around the world. The Archive is supported by libraries, scholarly societies, publishers, and foundations. It is an initiative of JSTOR, a not-for-profit organization with a mission to help the scholarly community take advantage of advances in technology. For more information regarding JSTOR, please contact support@jstor.org.

A QUANTITATIVE STUDY OF GROWTH AND PRODUCTION OF UNIONID MUSSELS IN THE RIVER THAMES AT READING

BY CHRISTINA L. NEGUS*

Department of Zoology, University of Reading

Five species of unionid freshwater mussels are found in the River Thames at Reading; of these *Anodonta anatina* (L.) and *Unio pictorum* (L.) are the most abundant, and *Anodonta minima* Millet and *Unio tumidus* Philipsson are less numerous; *Anodonta cygnea* (L.) is rarely found.

It has been suggested that the dark lines on the shell of a mussel are formed annually, and can therefore be used to determine age. The formation of a dark line during periods in which there is no growth is well established (Crowley 1957), and it has been shown for *A. cygnea* that there is no growth during the winter (see Chamberlain 1931; Weymouth & McMillin 1930). The lines on the shells of many marine bivalves have been proved to be winter rings (*Pecten maximus* Mason 1957, *Scrobicularia plana* Green 1957 and *Macoma baltica* Segerstråle 1960). Chamberlain (1931) justified this method of ageing freshwater mussels by the uniformity of the growth curves produced from a large number of specimens. Crowley suggested that the absence of regular fluctuations in the linear measurements between successive rings indicates that only one ring is formed in a year. However, both Crowley and Okland (1963) stated that considerable experience may be necessary to distinguish true annual rings from supernumerary rings, and Comfort (1957) stated that the deposition of one ring in a year must be checked.

During this investigation the dark rings were shown to be formed annually, and were used to calculate growth rates, age structure and annual production in a typical reach of the River Thames. Growth curves for mussels from the neighbourhood of the heated effluent of Earley Power Station were also produced. The age structure of the population was of particular interest as Isely (1911), Lefevre & Curtis (1910) and Crowley (1957) noted that young unionids were rarely found.

The embryos of *Anodonta* and *Unio* develop into glochidia larvae in the outer gill-chamber of the female. The glochidia then pass through a stage of parasitism on the fins (*Anodonta* spp.) or on the gills (*Unio* spp.) of fish, during which time they metamorphose into juvenile mussels. *Anodonta* spp. have a long breeding period, carrying mature glochidia from late summer until the following spring when they are released. *Unio* spp. have a short breeding season, from April to mid-August, and the glochidia are released as soon as they are mature (Lefevre & Curtis 1910; Coker *et al.* 1921). The timetable of breeding activity has been worked out for the Thames population and compared with temperature data.

SITE AND METHODS

The study was made in the same reach of the river as that illustrated by Williams (1965). All samples were taken between Williams's site 3 and site 5, particular attention being

* Present address: Department of Zoology, University of Durham.

paid to the 250 m reach just below Williams' site 3 (Fig. 1) and to the area round the heated effluent from Earley Power Station (Mann 1965a).

Sampling was carried out between October 1963 and March 1965 by grabbing, dredging and diving. The grab has been illustrated by Mann (1965a); the dredge is shown in Fig. 2. Samples were taken by adjusting the angle of the blade according to the hardness of the substratum and pressing down on the handle while towing. Non-quantified samples were also taken by hand and with a pond-net.

The dredge was converted into a Surber sampler by removing the blade and the handle, and adding a quadrat frame. Two series of samples were taken, with the assistance of a Thames Conservancy diving team, along the transects shown in Fig. 1. The dredge was placed on the river bed with the mouth facing upstream and the bottom deposits were moved by the diver from the quadrat area into the bag. The Surber samples totalled 4.62 m², and an area of 18.6 m² was sampled with the grab.

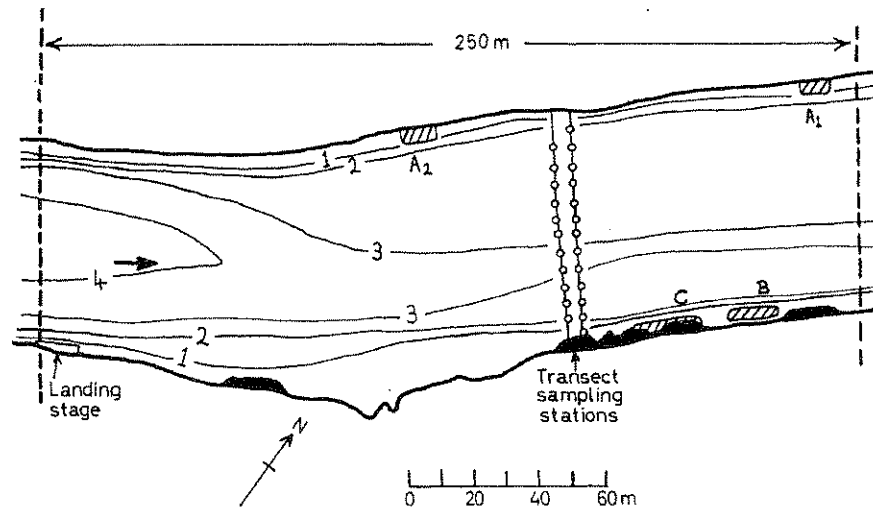

FIG. 1. Map showing main study area. Beds of *Acorus* are shown in black. The substrates of the mark-recapture sites (shown hatched) were: A1 (17.5 m²) and A2 (13 m²) sand and clay, becoming softer in deep water; B (32 m²) soft muddy sand; C (8 m²) silt. Depth contours are in metres.

All quantitative samples were sieved. The following data were recorded: shell length; number of winter rings; shell length at each winter ring; wet weight of shell; wet weight of living tissue (body weight); condition of gonads; and presence of embryos or glochidia in the gill-chambers.

All mussels used in the release-recovery experiments were marked by two methods. A paper label, numbered with Indian ink, was stuck on to the dorsal part of the shell where it would not be rubbed against stones, and was sealed over with a layer of adhesive. Using a dentist's drill, a second number was cut through the periostracum into the white prismatic layer in the ventral region of the shell where it would not be obscured by algal growth. The second method was completely successful, whereas some of the paper labels fell off.

Marked specimens of *Anodonta anatina*, *Unio pictorum* and *U. tumidus* were kept in aquaria. The tanks contained river mud and had a continuous flow of river water. Small mussels were kept in a separate tank where the amount of silt was reduced by a muslin trap.

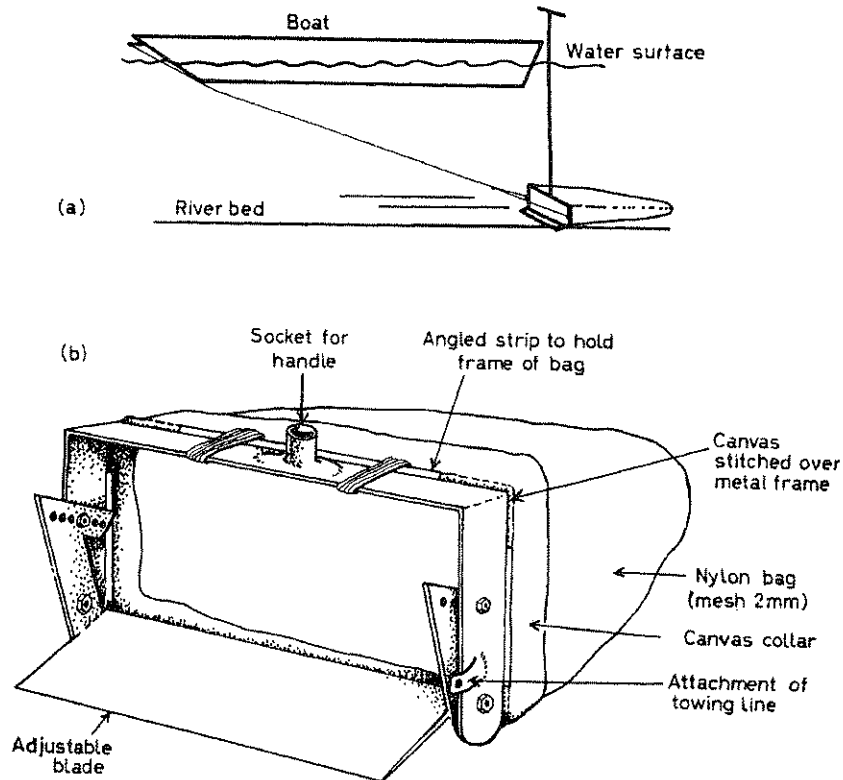

FIG. 2. (a) Operation of the dredge from the boat. (b) General view of the dredge. The handle is interchangeable with the grab, and consists of two sections of standard electrical conduit (5 ft and 8 ft in length) which can be used separately or together. An inner bag of 1 in. mesh tarred string is hooked on to the canvas collar to support the weight of large stones.

AGE DETERMINATION

Age in molluscs may be determined by (1) size-frequency studies, (2) release-recovery experiments, and (3) growth-interruption lines (Haskin 1954). Size-frequency studies on most bivalves are of little value, as recruitment is irregular and the size ranges of older year classes greatly overlap. Where all specimens from quantitative samples must be aged, analysis of growth-interruption lines is more practicable than extensive release-recovery experiments, although the latter method and a demonstration of the time of ring formation were used as a check.

Table 1. *Three specimens from mark-recapture experiments*

	Date	Total length (cm)	Age (winters)	Length of shell at winter rings (cm)
<i>Anodonta anatina</i> (C29)	6 August 1963	53.0	2	
	29 September 1964	63.5	3	21.5, 40, 53*, 55.5
<i>Unio tumidus</i> (C.11)	8 August 1963	73.0	5	
	29 September 1964	78.0	6	29.5, 56.5, 63, 67.5, 69.5, 73*, 76
<i>U. pictorum</i> (A.93)	2 August 1963	49.0	4	
	29 September 1964	52.0	5	10, 23.5, 36.5, 43.5, 49*, 50.5

* Indicates 'false rings' caused by handling.

Numbers in *italics* are the lengths at the winter ring of 1963-64.

Five hundred and seventy-five mussels were marked in August 1963; fifty-six were subsequently recaptured of which forty-three could be confidently aged. Thirty-seven (twenty-two *Unio pictorum*, five *U. tumidus* and ten *Anodonta anatina*) had a clearly recognizable ring laid down in the winter of 1963-64. Ten specimens were collected during the winter period (six *Unio pictorum* in January 1964 and four *Anodonta anatina* recaptured for the second time in February 1965) before the ring could be seen. Twenty-five had produced a 'false ring' when they were first handled. Examples from each species are given in Table 1.

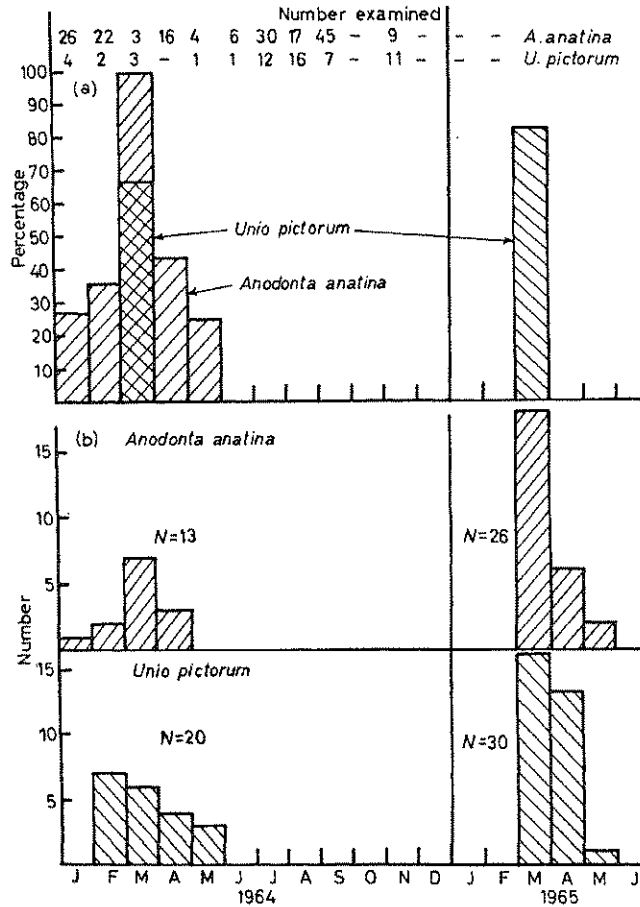

FIG. 3. Months when winter rings first become visible. (a) Mussels from river. Percentage of 1-3-year-old *Anodonta anatina* with less than 0.5 mm growth in length, after last ring. Percentage of 1-3-year-old *Unio pictorum* with up to 1.5 mm growth after last ring. (b) Mussels in aquaria. Number per months with winter ring just formed.

The average shell-lengths of river specimens and of mussels in aquaria of the same age throughout the year are shown in Figs. 7 and 8; it is clear that there is no growth in winter. The growth-interruption line was seen near the edge of the shell, as soon as growth was resumed in spring. Only one such line was formed in a year (Fig. 3). Mussels in the aquaria formed a 'false ring' each time they were handled; this is best seen in young fast-growing animals. These disturbance rings are easily distinguishable from annual rings.

The observations on the development of embryos in the gill-chambers during 1964 showed that glochidia were released by *Anodonta* spp. from late February to early April,

and by *Unio* spp. in mid-summer (June to July and possibly earlier). Fish kept in aquaria with *Anodonta anatina* were infected with glochidia in March 1964 and the duration of the parasitic period was approximately 3 weeks. Thus *A. anatina* has approximately 9 months growth before the first winter-ring; the breeding season of *Unio* spp. is much more spread out, but many individuals would be less than 6 months old at their first winter. For the purpose of further calculations, the dates at which the young mussels drop off the fish were taken as 1 April (*Anodonta* spp.), and 1 August (*Unio* spp.).

GROWTH

Growth in length and seasonal growth

During the period January 1964 to March 1965, the shell-lengths of 1059 living mussels were measured at all the winter growth-interruption lines. The yearly growth increments

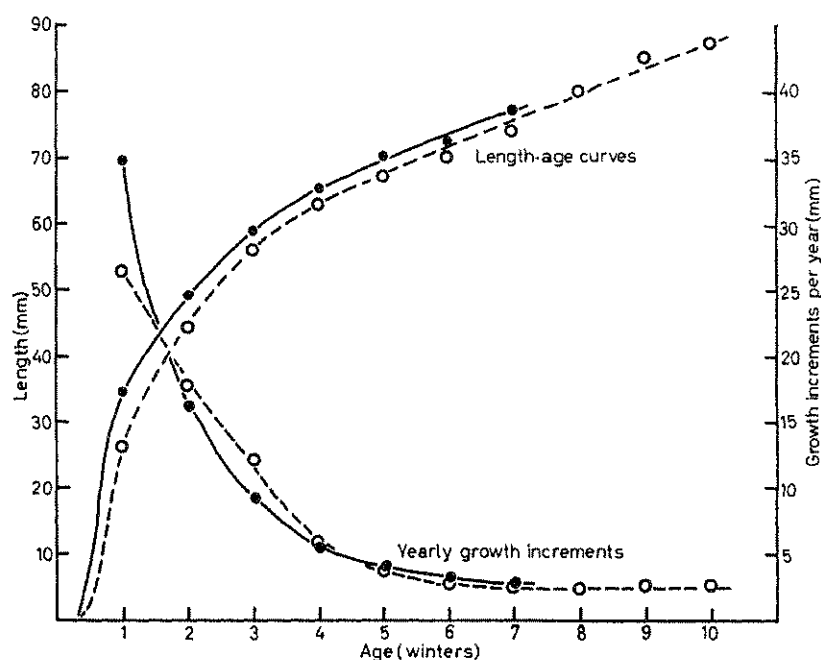

FIG. 4. *Anodonta anatina*. Length at winter rings and annual growth increments, from the effluent (●) ($N = 96$) and from unheated habitats (○) ($N = 420$).

and the relationship between shell-length and age for four species are shown in Figs. 4–6. For *Anodonta anatina* and *Unio pictorum* growth curves are shown separately for animals from natural habitats and from the heated Power Station effluent. Sufficient numbers of *Anodonta minima* and *Unio tumidus* for growth analysis could be collected from unheated habitats only.

Growth during the first 9 months of life in *Anodonta anatina* is considerably greater downstream from the effluent than it is where the river is not artificially heated. This is unlikely to be due to a delay of the start of the winter growth-interruption period, as later yearly increments below the effluent are less than, or the same as, those in natural habitats (Fig. 4). The release of glochidia of *A. anatina* in the spring of 1964 occurred with the first temperature rise after the winter. Thus increased temperature below the effluent would probably cause earlier breeding, and a correspondingly longer growing season during the first summer period. Fig. 9 shows the lengths of 0-year-old *A. anatina* collected from July 1964 to March 1965 from heated and unheated habitats.

The growth increments of *Unio pictorum* below the effluent are greater than in unheated habitats in all years of life except the first (Fig. 5). Unlike those of *Anodonta* spp., the glochidia of *Unio* are retained in a marsupium only until they reach maturity,

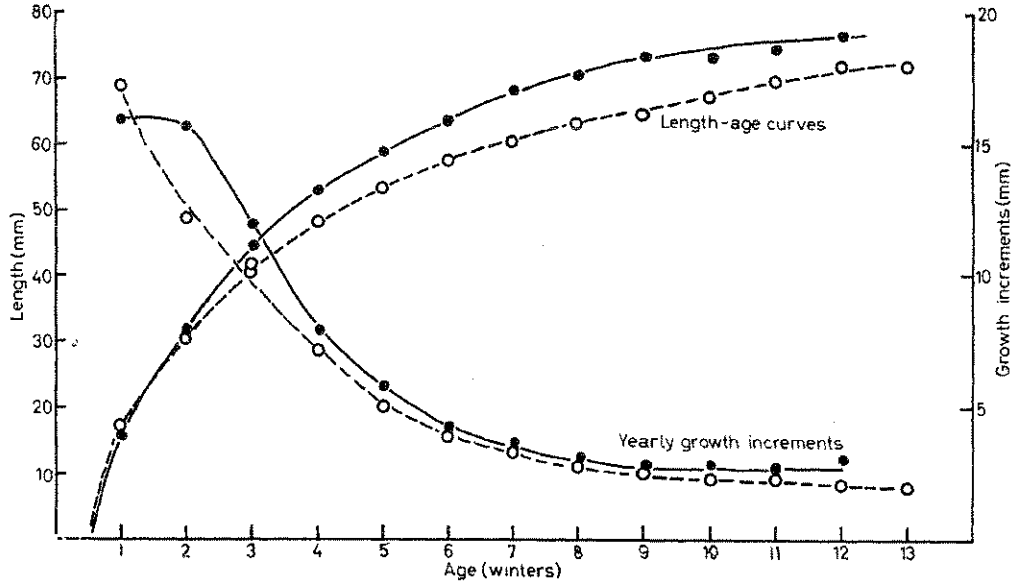

FIG. 5. *Unio pictorum*. Length at winter rings and annual growth increments, from the effluent (●) ($N = 159$) and from unheated habitats (○) ($N = 329$).

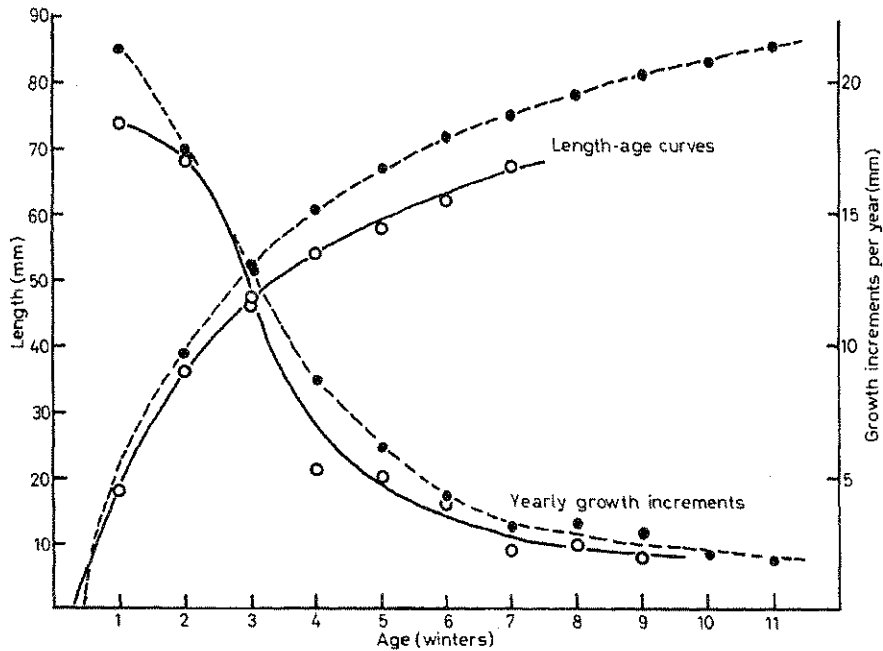

FIG. 6. *Unio tumidus* (●) ($N = 44$) and *Anodonta minima* (○) ($N = 11$). Length at winter rings and annual growth increments, from unheated habitats.

and are then immediately released; this does not appear to be correlated with change in river temperature. On the other hand, the winter growth-interruption period of *U. pictorum* seems to be shortened by artificial heating, and the winter rings are generally fainter in specimens from the effluent than in those from natural habitats.

As growth (and also population age structure) in the effluent is atypical, specimens obtained from the heated effluent are omitted from further calculations of growth and production relating to a typical reach of the river.

The seasonal growth in length of *Anodonta anatina* and *Unio pictorum* is shown in Figs.

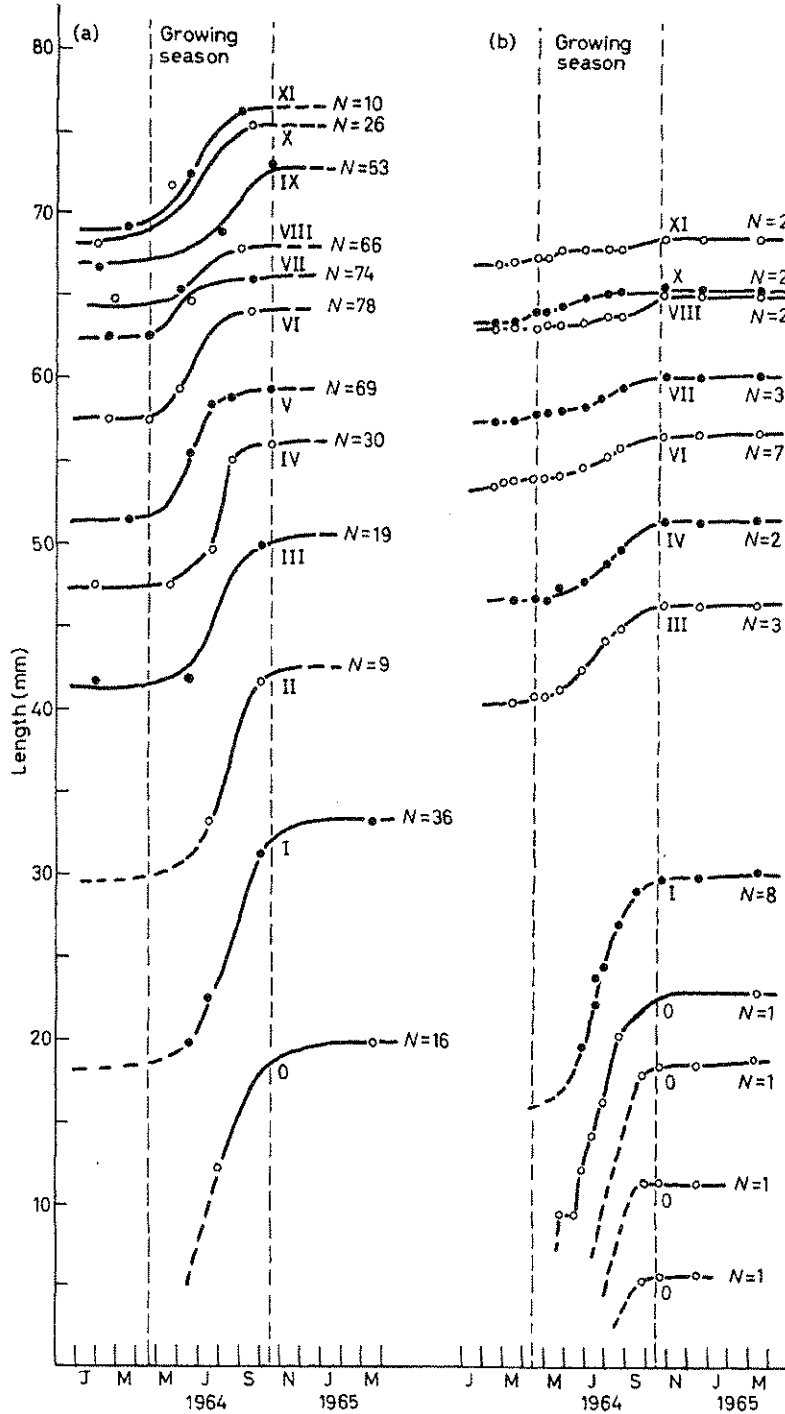

FIG. 7. Seasonal growth of *Anodonta anatina*. (a) From river; average lengths for different sampling periods. (b) From aquaria; the same specimens measured at intervals.

7 and 8. The pattern of growth in the river can be most clearly seen in I, IV and V-year-old *U. pictorum* and in I, IV, V and VI-year-old *Anodonta anatina*. The length of the winter growth-interruption period and the varying rates of growth during the summer are confirmed by the measurements of mussels in the aquaria. These curves may easily be fitted to less complete data from river specimens. During 1964, the growing season was approximately 6 months, from mid-April to mid-October, with the most rapid

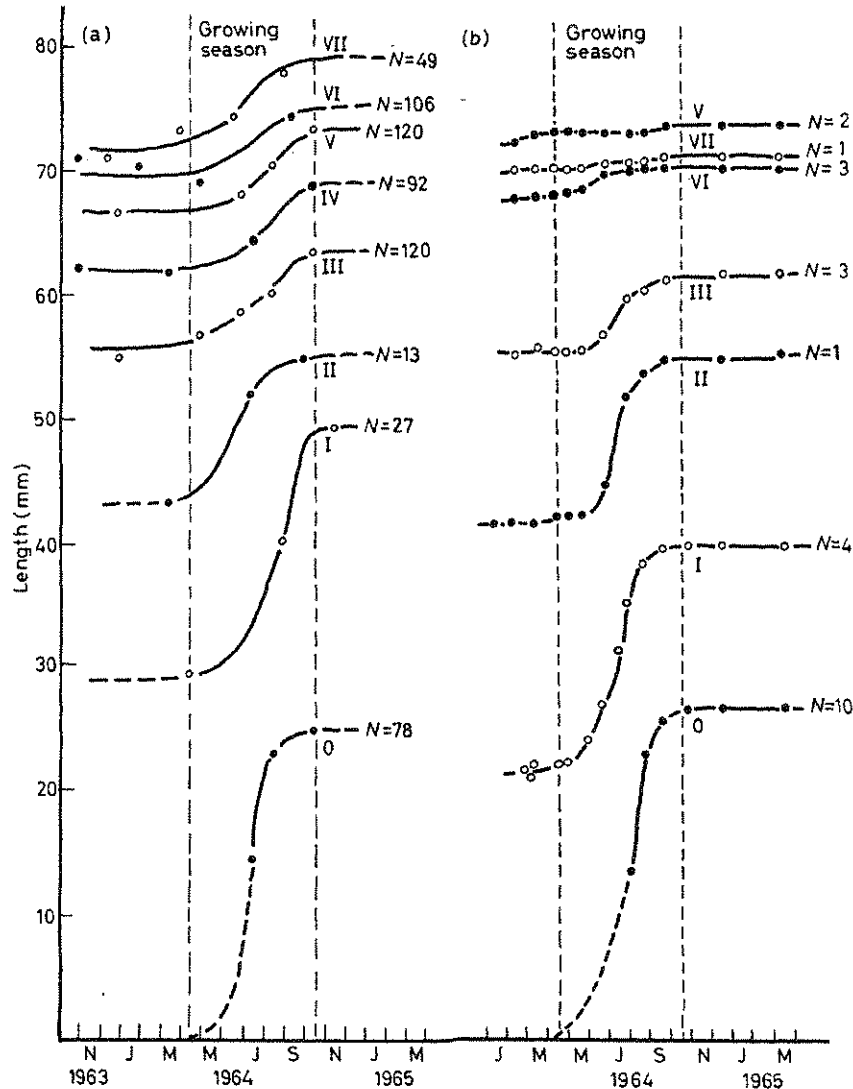

FIG. 8. Seasonal growth of *Unio pictorum*. (a) From river; average lengths for different sampling periods. (b) From aquaria; the same specimens measured at intervals.

growth during June, July and August. The same pattern of seasonal growth can be demonstrated for shell weight, and for weight of living tissue.

Yearly variation in growth increment

By recording shell length at each winter ring of a large number of living mussels, it was possible to calculate the average growth increment in each year of life for animals born in each calendar year back to 1954 (*A. anatina*) or 1951 (*Unio pictorum*). These figures were

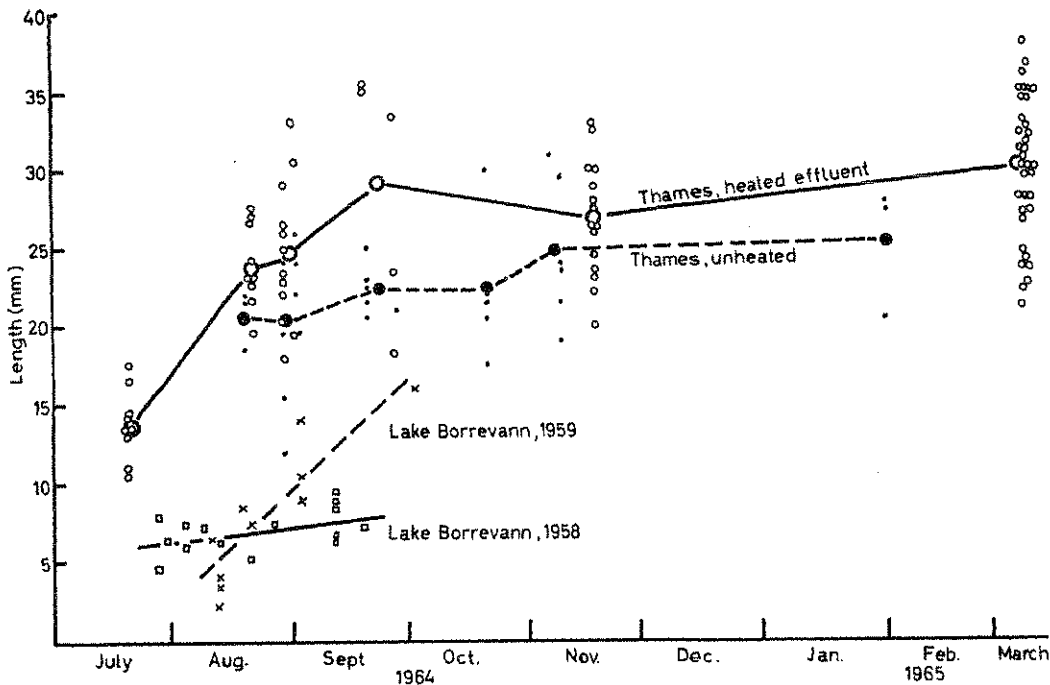

FIG. 9. Lengths of *Anodonta anatina* 0-year-olds from the River Thames and Lake Borrevann, showing individual specimens and the means for each sampling period. For Lake Borrevann, the lines are fitted by eye.

expressed as percentage deviation from the mean growth for each year of life. The percentage deviations for each calendar year were then averaged, giving one number for each year; these are plotted in Fig. 10 and indicate the years which were relatively good or bad for growth.

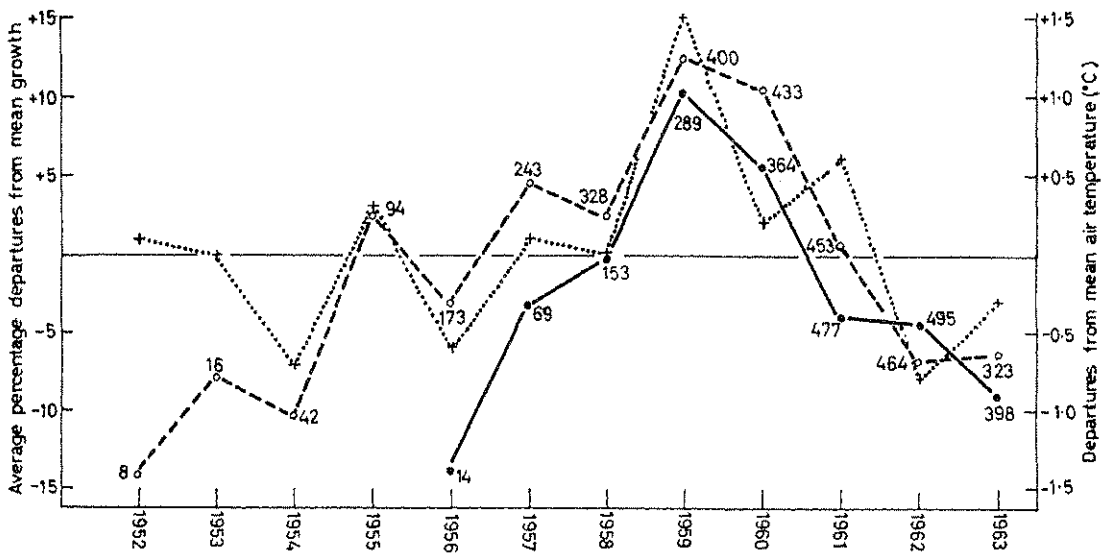

FIG. 10. Good and bad years for growth, correlated with average temperature (+) during growing season. The mean growth for *Anodonta anatina* (●) is for all years 1954-63, and for *Unio pictorum* (○) 1951-63. The mean air temperature is for April-October, all years 1952-63. The figures indicate the number of mussels represented by each point. (The three points with figures less than 20 are probably unreliable.)

Howard (1921) demonstrated the close relationship between the growth of freshwater mussels and river temperature. A similar relationship is shown in Fig. 11 for a 1-year-old *Anodonta anatina*. This suggests that the yearly variation of growth might be due to temperature differences between one year and the next, and the mean river temperature during the growing season (April to October inclusive) has been calculated for all years from 1952 to 1963. These are expressed as deviations from the 12-year mean, and plotted with the data for good and bad growing years (Fig. 10). The close agreement between yearly growth and temperature is additional evidence for the validity of the method of age determination.

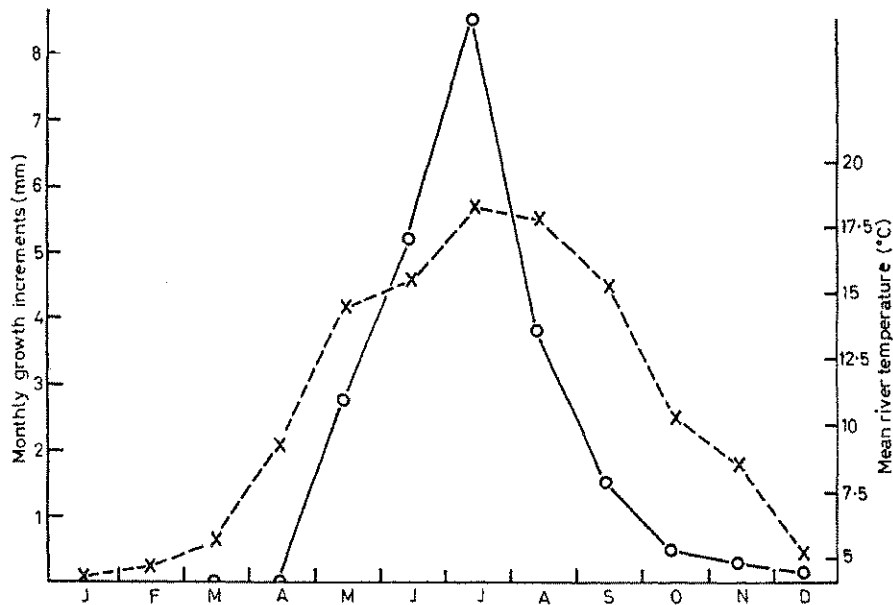

FIG. 11. Monthly growth increments (○) of a 0-year-old *Anodonta anatina* in the aquarium, correlated with river temperature (×).

Growth in weight and instantaneous growth rate

The shell weights and wet body-weights of all mussels of the same age, collected over the same sampling period, were averaged. The relationship between weight and age in *A. anatina*, *Unio pictorum* and *U. tumidus* is shown in Figs. 12 and 13. The numbers of *Anodonta minima* collected were insufficient for similar analysis. Plots of wet body weights against shell length indicated that gravid female *A. anatina* were considerably heavier than others of the same length; these were therefore plotted separately. (This does not apply to *Unio pictorum* or *U. tumidus*.)

The weights at successive mid-winters were read from the growth curves and used to calculate the instantaneous growth rate on a yearly basis from the equation:

$$g = \log_e \left(\frac{W_t}{W_o} \right)$$

where g = instantaneous growth rate, W_o and W_t are successive measurements of weight, and $t = 1$ year.

As the growing season is approximately 6 months, values of $2g$ were also calculated giving the instantaneous growth rate over this period. Values of $2g$, for all complete years of life, are given for the three species in Table 2.

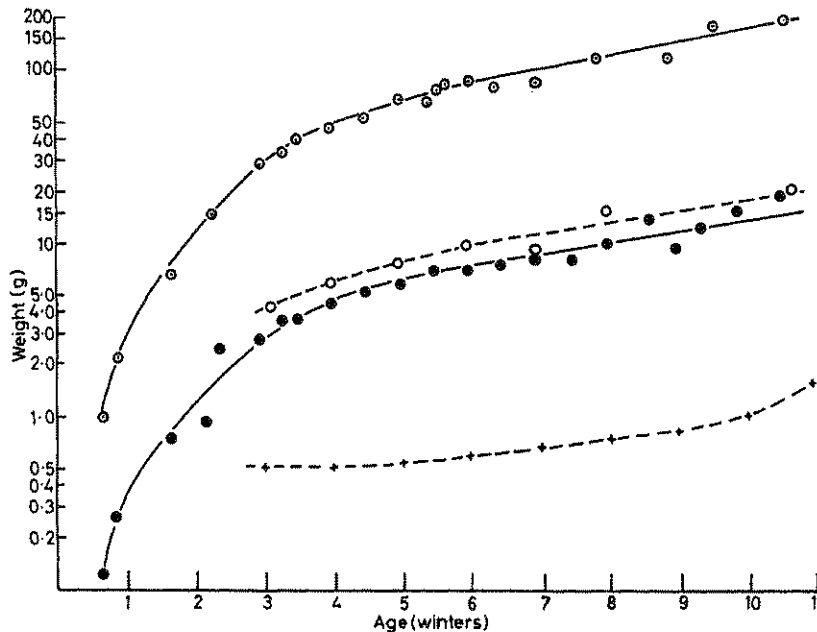

FIG. 12. Growth in weight of *Andonta anatina*. All specimens are from sites not artificially heated. The weight of glochidia is calculated at each midwinter from the curve for body weight of gravid females (see p. 529). ○, Shell weight $\times 10$; ○, body weight of gravid females; ●, body weight; +, glochidia.

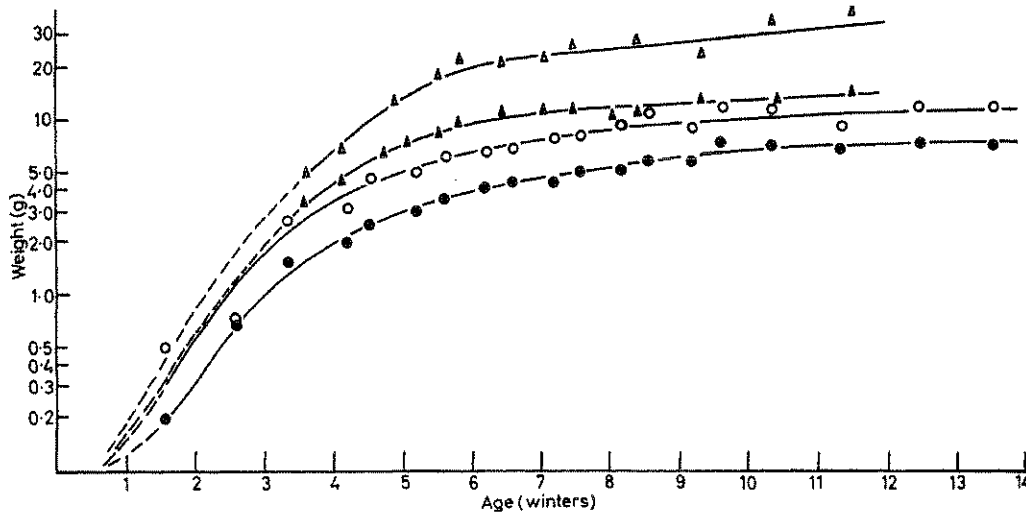

FIG. 13. Growth in weight of *Unio* spp. All specimens are from sites not artificially heated. Δ , *U. tumidus*, shell; \blacktriangle , *U. tumidus*, body; ○, *U. pictorum*, shell; ●, *U. pictorum*, body.

The instantaneous growth rate for the period before the first winter has also been determined. As there is practically no growth during the parasitic stage (Coker & Surber 1911), the average weight of mature glochidia of *Anodonta anatina* (0.066 mg) has been taken as the weight at the beginning of benthic life, for all three species. The

values of g are, *A. anatina* 8.55 (for a 9-month period), *Unio pictorum* 7.59, and *U. tumidus* 7.85 (both for a 5-month period).

AGE STRUCTURE

All specimens collected by methods which are not selective for size are included in the analysis. Percentage age-frequencies have been calculated for *Anodonta anatina*, *Unio pictorum* and *U. tumidus* (Figs. 14 and 15).

Table 2. Instantaneous growth rates (2g calculated to allow for the whole year's growth taking place during a 6-month growing season)

Age (winters)	<i>Anodonta anatina</i>		<i>Unio pictorum</i>		<i>U. tumidus</i>	
	Body weight (g)	2g	Body weight (g)	2g	Body weight (g)	2g
1	0.34		0.13*		0.17*	
2	1.2	2.52	0.33	1.86	0.58*	2.45
3	2.8	1.69	1.0	2.22	1.8*	2.26
4	4.5	0.95	2.0	1.39	4.2	1.69
5	5.9	0.54	3.0	0.81	7.1	1.05
6	7.1	0.37	3.9	0.52	9.5	0.58
7	8.3	0.31	4.6	0.33	11.0	0.29
8	9.8	0.33	5.4	0.32	12.0	0.17
9	11.3	0.29	6.2	0.28	12.7	0.11
10	13.2	0.31	6.8	0.19	13.2	0.08
11	15.3	0.30	7.3	0.14	13.8	0.09
12			7.5	0.05	14.3	0.07
13			7.7	0.05		
14			7.9	0.05		

* No specimens of these ages were weighed; the values given are derived from extrapolating back the known growth curve.

If recruitment was regular, an age-frequency histogram would be expected to show a gradual decrease in numbers with increasing age. This is obviously not so; in the case of *Anodonta anatina* (Fig. 14a) those born in 1958 and 1959 (6- and 5-year-olds in 1964) are most numerous, whereas recruitment in 1962 and 1963 was very poor. As *Unio* and *Anodonta* breed at different seasons, the years of good recruitment in each species will not necessarily coincide. In *Unio pictorum*, recruitment in unheated habitats has been poor in all years back to 1959, and the 1956 year class (8-year-olds in 1964) is the most numerous (Fig. 15a).

In 1964, young *U. pictorum* (up to 5-year-olds) were relatively more abundant in the effluent than in the rest of the river (Fig. 15b) and *Anodonta anatina* 0-year-olds were the

most numerous age class in the effluent (Fig. 15c), and were abundant along the edges of reed beds and beneath landing stages. These are all areas where fish are known to congregate to breed. The recruitment in each year may perhaps depend to some extent on the

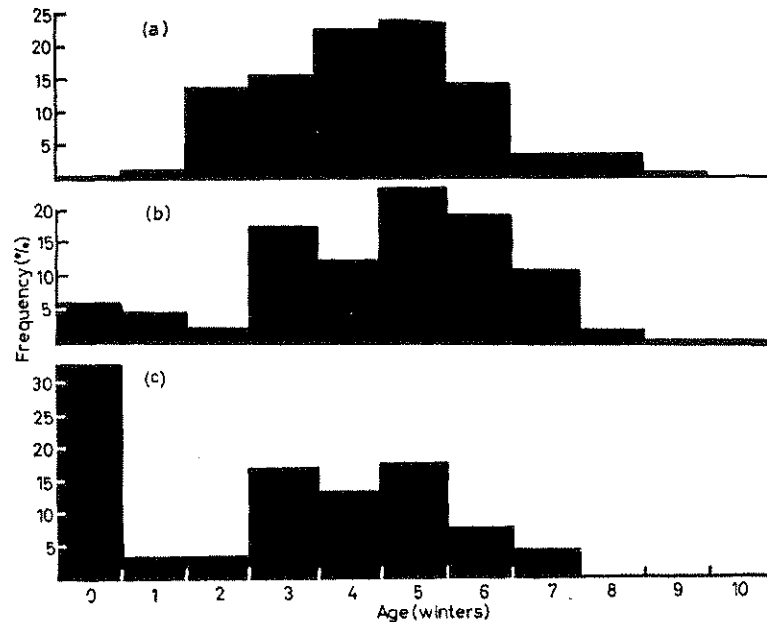

FIG. 14. Percentage age frequency of *Anodonta anatina*. (a) 1963, unheated, No. of mussels 146; (b) 1964, unheated, No. of mussels 412; (c) 1964, heated, No. of mussels 142.

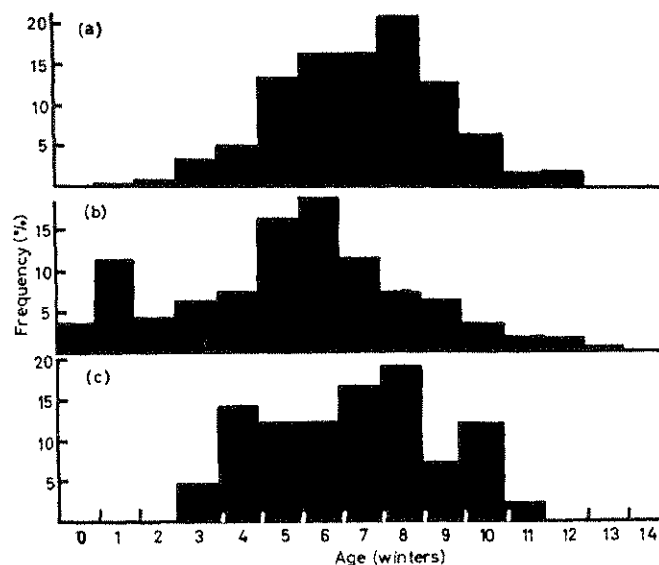

FIG. 15. Percentage age frequency of *Unio* spp. 1964. (a) *U. pictorum*, unheated, No. of mussels 336; (b) *U. pictorum*, heated, No. of mussels 176; (c) *U. tumidus*, unheated, No. of mussels 42.

release of glochidia coinciding with fish breeding activity. The better recruitment in these areas may also be related to substratum. The fine shelly gravel, rich in organic matter, is found only in the effluent. It is easy for small mussels to burrow into, and unlike silt or mud, would not choke the gills. Away from the effluent, young mussels

were found in organic sand or loam and were very rare in mud and silt. The incidence of river spate and subsequent deposition of fine silt must also affect breeding success, especially of *Anodonta* spp. as spring floods will often occur during early juvenile life.

The age-frequency histograms for *A. anatina* from unheated habitats have the same general shape in 1963 and 1964, the majority of the animals in 1963 having between two and six winter rings, and between three and seven in 1964 (Figs. 14a and b). Thus one ring is added during the winter. The apparent increase in numbers of the 1964 1-3-year-olds compared with the previous year is due to more widespread sampling during the later part of the work.

THE RATE OF MORTALITY OF *ANODONTA ANATINA*

As recruitment is irregular, the mortality rate cannot be calculated from the shape of a 'catch curve' (age-frequency curve), and it is necessary to compare the age structure of the population in two successive years.

The age structure of *Unio* spp. in 1963 has not been calculated as few specimens of *U. tumidus* were collected, and the age determinations of *U. pictorum* in 1963 may not be reliable. The mortality rate has therefore been estimated for *Anodonta anatina* only.

Table 3. Annual survival rates (*S*) and instantaneous mortality rates (*z*) of *Anodonta anatina*

Age (winters)	From percentage frequencies		From ratios of numbers	
	<i>S</i>	<i>z</i>	<i>S</i>	<i>z</i>
5-6	0.8623	0.15	0.7776	0.25
6-7	0.8088	0.21	0.7296	0.32
7-8	0.6813	0.38	0.6105	0.49
8-9	0.1520	1.88	0.1355	2.00

There are no data on which to base estimates of mortality in the first year of life. The figures show no evidence of measurable mortality in the second to fifth years. Attention is therefore concentrated on mortality from the age of 5 onwards.

The survival rate was first estimated by comparing the percentage frequency of a year class in two successive years (omitting year 0 in 1964). This has the disadvantage that if the number of specimens in any age group changes from one year to the next, the percentage in all other age groups will be affected. An alternative is to assume that the number of 4-year-olds taken in 1963 is equivalent to the number of 5-year-olds in 1964 (there being no mortality), and to use this as a baseline, comparing the ratios of older age groups to this age group, in the two years. Thus the survival rate between the ages of, say, 5 and 6 years is found by comparing the ratios:

$$\frac{\text{In 1963}}{\text{No. of 5-year-olds}} \div \frac{\text{No. of 4-year-olds}}{\text{No. of 5-year-olds}} = \frac{\text{In 1964}}{\text{No. of 6-year-olds}} \div \frac{\text{No. of 5-year-olds}}{\text{No. of 5-year-olds}}$$

The values for instantaneous mortality rate, given in Table 3, are based on the relationship:

$$S = (1 - a) = e^{-z}$$

where *S* = annual survival rate, *a* = annual mortality rate, and *z* = instantaneous

mortality rate. Because of the close agreement, both estimations of S and z are given, although the second is likely to be the more accurate.

POPULATION DENSITY

The density of each species was estimated from all quantitative samples (grabs and transects from sites not heated artificially), and also from the mark-recapture data using

Table 4. *Population densities (number per square metre): Comparison of estimates by quantitative sampling and by mark-recapture experiments*

Sites investigated:	Close to north bank		Reed beds		Bays, south bank		All three areas	
Mark-recapture sites:	A1, A2		C		B		A1, A2, B, C	
Method of estimating density:	Lincoln		Lincoln		Lincoln		Lincoln	
Area (m):	index	Grab	index	Grab	index	Grab	index	Grab
<i>Anodonta anatina</i>	5.5	7.19	152.3*	25.35	9.0	†	15.41	14.97
<i>Unio pictorum</i>	30.9	7.88	87.8	13.89	41.48	†	39.5	10.90
<i>U. tumidus</i>	4.2	1.71	2.5	2.43	3.1	†	2.03	2.07
<i>Anodonta minima</i>	—	—	—	0.69	—	†	—	—
All species	43.0	16.78	236.2	42.36	52.2	†	59.3	28.34

* No marked specimens were recaptured; the figure is calculated as if there was one marked recapture.

† No grab figures are available for comparison due to insufficient grab-sampling in this area.

the Lincoln Index. The two methods were used in the same areas and give comparable results for *Anodonta anatina* and *Unio tumidus*, but the Lincoln Index gives a much greater figure for *U. pictorum* than the data from quantitative sampling (on average, 3.6 times greater). The difference between estimates is greatest for Site C. As this is a very narrow sampling area, the movement of marked specimens into the reeds on one side and into deep water on the other, must be considerable. (No marked specimens of *Anodonta*

Table 5. *Density calculated from quantitative samples (grabs and quadrats)*

Depth range (m)	<i>Anodonta</i>		<i>Unio</i>	
	<i>anatina</i>	<i>A. minima</i>	<i>pictorum</i>	<i>U. tumidus</i>
0-1	40742.90 (14.968)	865.60 (0.318)	29906.61 (10.987)	5634.54 (2.070)
0-2	16880.50 (11.375)	213.70 (0.144)	14957.24 (10.079)	2991.74 (2.016)
2-3	102276.16 (12.577)	4595.15 (0.565)	44820.96 (5.411)	12638.68 (1.554)
3+	17546.30 (3.423)	3512.00 (0.685)	35105.57 (6.847)	3512.00 (0.685)
All depths	177445.86 (11.712)	36562.07 (0.388)	124789.38 (8.526)	24776.96 (1.722)

The number of mussels in the reach of the river; the average number per square metre is given in parentheses.

anatina were recovered here.) These results (see Table 4) suggest that the discrepancies are due to the movement of marked specimens, and that *Unio pictorum* moves greater distances than the other species. The data from grabs and quadrats were therefore regarded as more reliable.

The density of the population in each depth range was calculated from the data from quantitative sampling (excluding the effluent), and is shown in Table 5. The number of

mussels per unit area is generally greatest in shallow water, decreasing with increasing depth. The density and weight of standing crop, and the annual production have been calculated for the reach shown in Fig. 1. The area between each metre depth contour was calculated and the density figures integrated for the entire reach (Table 5). The greatest number of mussels of all species is found between the depths of 2 and 3 m, and the average number per m² over the whole reach is *Anodonta anatina* 11.7, *Unio pictorum* 8.5, *U. tumidus* 1.7 and *Anodonta minima* 0.4, giving a total of twenty-two mussels per square metre.

An indication of the accuracy of the density estimate is obtained by considering the fiducial limits of the mean for data obtained by one particular method, e.g. single grabs. The average per square metre, and fiducial limits for $P = 0.05$, are *A. anatina* 11.275 ± 2.593 ; *Unio pictorum* 12.600 ± 2.900 ; all species 24.100 ± 4.075 . Generally speaking, confidence limits for the estimates are near $\pm 20\%$.

STANDING CROP AND PRODUCTION

The weight of the standing crop for the winter of 1964–65 has been estimated for each depth range of the chosen reach of the river. The number of mussels in each age group for each species was calculated from the total number of mussels in each depth range and

Table 6. *The standing crop during the winter of 1964–65*

Depth range (m)	<i>Anodonta</i>		<i>Unio</i>	
	<i>anatina</i>	<i>A. minima</i>	<i>pictorum</i>	<i>U. tumidus</i>
0–1	260.9 (958.5)	3.4 (12.7)	160.3 (588.8)	62.0 (227.7)
1–2	104.4 (703.5)	0.9 (5.7)	79.9 (538.7)	32.9 (221.8)
2–3	655.0 (805.4)	18.3 (22.5)	239.5 (294.5)	139.1 (171.0)
3+	112.4 (219.2)	14.0 (27.3)	187.6 (365.9)	38.6 (75.4)
All depths	1132.7 (648.2)	36.6 (20.9)	667.4 (382.1)	272.6 (156.1)

Total biomass (wet body-weight) in kg in the reach of the river; the average kg/ha is given in parentheses.

the percentage frequency (age–frequency figures are for 1964 and exclude the effluent). Each of these figures was multiplied by the average winter body weight for the appropriate age, taken from the growth curves (Figs. 12 and 13). As the numbers of *Anodonta minima* collected were too low to produce reliable age–frequency figures, an approximate estimate of standing crop was found by multiplying the number in each depth range by the average body weight of all specimens.

The total biomass (minus shell-weight) for each depth range, and for the whole reach, and the average weight per hectare, are shown in Table 6. The standing crop of the whole reach for all species is 2109.3 kg, an average of 1207.7 kg/ha. In order to compare the standing crop in the Thames with other habitats, the biomass including weights of shells has also been calculated, giving an average of 2921.58 kg/ha for all species combined.

The production in the selected reach of the river was calculated for each age, by multiplying the annual increment in body weight (taken from the growth curves, Figs. 12 and

13) by the number in each group. Production in *A. minima* cannot be estimated as insufficient figures are available for the construction of a growth curve. The total production of body tissue during 1964 for the whole reach, and the average production per hectare is given in Table 7. The standing crop of all species combined is 5.89 times greater than the production of body tissue in 1964; the factors for each of the species are: *A. anatina* 4.90, *Unio pictorum* 7.22 and *U. tumidus* 7.81. Thus the two *Unio* spp. have a slower rate of growth of body tissue, and a longer life span, than *Anodonta*.

The difference between the body weights of gravid and non-gravid specimens of *A. anatina* of the same age gives an indication of glochidial production. A correction has been made for the weight of water held in the gill chambers, and the average weights of glochidia produced at each age are shown in Fig. 12. These figures were multiplied by the

Table 7. *Production of body tissue in 1964*

	Total production in reach (kg)	Average (kg/ha)
<i>Unio pictorum</i>	92.4	52.9
<i>U. tumidus</i>	35.0	20.0
<i>Anodonta anatina</i>	230.9	132.2
All three species	358.5	205.1

number of breeding females of each age in the reach of the river giving a figure for the total glochidial production of 38.4 kg, that is 19.9 kg/ha.

DISCUSSION

The growth in length of *Anodonta anatina* in the River Thames has been compared with growth in the River Colne, at Denham (Crowley 1957) and in two Norwegian lakes (Ökland 1963) (Fig. 16). Growth in the Thames and in the Colne is very similar, especially for the first 4 years of life. The two rivers flow across the same geological formations, and the temperature régimes and therefore time of breeding and length of growing season are approximately the same. Growth during the first summer in the two Norwegian lakes is less than in the River Thames and River Colne (see also Fig. 9). In Lake Borrevann the ice-cover lasts until mid-April. The release of glochidia is therefore likely to be later, and the first year's growing season correspondingly shorter than in southern England. The summer temperatures in the Norwegian lakes are higher than in the River Thames, which probably accounts for the rapid growth in later years of life in Norway. Ökland suggested that the faster growth in Östensjøvann, in comparison with Borrevann, may be due to higher summer temperatures and to sewage pollution. Neither the growth of *Unio* spp., nor of *Anodonta* in terms of weight, appear to have previously been studied.

Crowley considered that an average age of 5 years, and a maximum age of 9 years, was typical of *A. anatina* in the Thames valley. No specimen longer than 95 mm had been found. The results from Reading confirm this; only two 10-year-olds were found, and the longest specimen was 99.5 mm. Ökland stated that the normal life-span in Europe was less than 10 years, with a maximum age of 15. The greatest length of *A. anatina* in all the localities reviewed was more than in the Thames (up to 155 mm). *Anodonta* in the Thames is therefore relatively short-lived and slow growing. The maximum lengths and ages of *Unio* spp. from the Thames were 99.0 mm and 15 years (*U. pictorum*), and 92.5 mm and 11 years (*U. tumidus*). Segerstråle (1960) listed the known life-spans of bivalves and gave a figure of 8–10 years for both species of *Unio*.

The average standing crop of mussels (including shell weights) in Lake Borrevann is 2593 kg/ha, and in the Thames is 2922 kg/ha. As the habitats are quite different, the densities are surprisingly similar, particularly as the Borrevann population is composed entirely of *Anodonta anatina*.

The standing crop of mussels is very large in comparison with other organisms. In Lake Borrevann they represent 95.7% of the bottom fauna, and Mann (1964) found that they account for more than 90% of the energy content of the bottom fauna in the River Thames. The density and annual production of fish have been calculated for the same reach of the Thames (Mann 1965b). The standing crop of fish is 659 kg/ha, approximately half the standing crop of mussels (excluding shells). However, the ratios

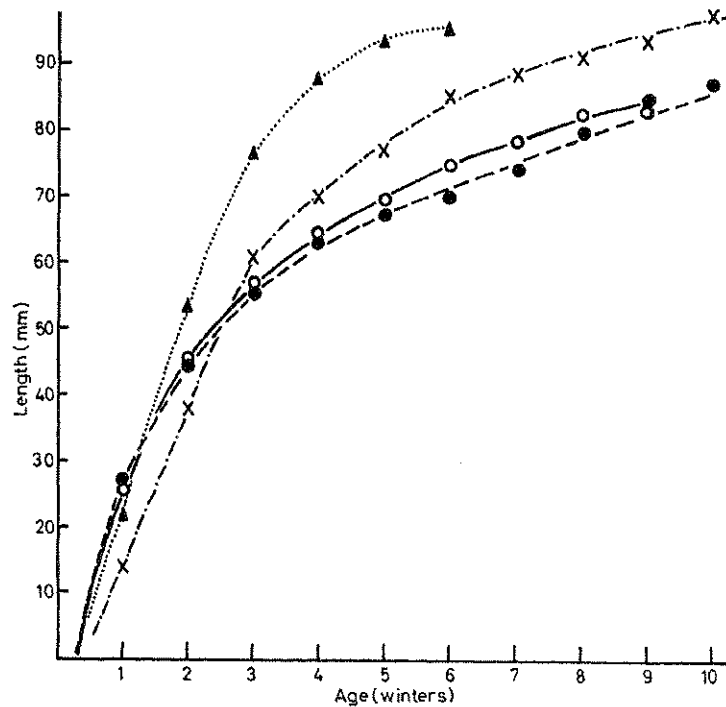

FIG. 16. Growth of *Anodonta anatina* in the River Thames at Reading (●), compared with growth in other localities: ▲, Östensjövänn; ×, Lake Borrevann; ○, River, Colne. Lengths at winter rings.

of production to standing crop are 2 : 3 for fish, and 1 : 6 for mussels. The annual production of fish is thus twice that of mussels. The low ratio of production to standing crop is probably typical of long-living bivalves. The population of *Modiolus demissus* studied by Kuenzler (1961) on a Georgia salt-marsh had a production-standing crop ratio of approximately 1 : 5. On the other hand, the production of short-lived invertebrates may be many times the standing crop, for instance the ratio given by Borutzky (1939) for *Tanypus* is 8.45 : 1.

The part played by the mussel population in the ecosystem as a whole can now be seen. The bottom fauna consists largely of animals feeding on organic detritus. The greatest bulk is made up of mussels, which are long-lived and accumulate production over several years. Live mussels are taken by fish only when very small. The large standing crop therefore represents a large amount of energy of no immediate value to the trophic level above. However, the number of mussels which die in a year will be considerable.

If the standing crop remains fairly constant, an amount of mussel flesh approximately equal to the annual production will be available for food for bottom-feeding fish, scavenging invertebrates and decomposer organisms. A small amount of organic material present in the shells, which is not included in the estimate of annual production, will also be returned to the ecosystem on decomposition.

Juvenile *Anodonta anatina* (0-year-olds) were found commonly in the Thames in 1964. This seems to be the first time that such numbers have been located. Isely (1911) stated that juvenile mussels must be free from shifting sand and silt accumulation, and young specimens found by Howard (1921) in the Mississippi were on current-swept gravel, free from silt. The majority of the Thames juveniles (of all species) were found around the Power Station effluent where silt is absent, the substrates being broken-shell gravel, with varying amounts of organic material, or small pebbles. Juveniles were also found away from the effluent in soft particulate organic soil, in soft sand and in gravel. Very few were found in silt, or in the main bed of the river which is hard and stony. Juvenile mussels therefore require a stable substratum free from silt, but soft enough for such small animals to burrow into. With increasing canalization and dredging of rivers, such areas are likely to be rare and young mussels uncommon.

ACKNOWLEDGMENTS

I should like to express my gratitude to Professor Alaistair Graham for providing research facilities in the Department of Zoology, University of Reading; to Dr K. H. Mann for his advice and interest in supervising the work and for criticizing the manuscript; and to the Chief Engineer, Thames Conservancy, for the loan of divers and equipment on two occasions. The work was carried out during the tenure of a D.S.I.R. Research Studentship.

SUMMARY

1. Growth rates, age structure, biomass and production were studied on populations of *Anodonta anatina*, *A. minima*, *Unio pictorum* and *U. tumidus* in the River Thames near Reading.
2. The dark lines on the shells were shown to be annual winter rings. This was established by regular examination of field and laboratory populations, and by recapture of marked specimens.
3. The growing season is from mid-April to mid-October; the dark lines are laid down during the 6 months in which there is no growth.
4. The age structure of populations of *Anodonta anatina* in 1963 and 1964 was compared. Recruitment is irregular; in 1964 young specimens were found in large numbers. Mortality is low during the sixth year of life, gradually increasing to the eighth, and becoming very high during the ninth year of life.
5. Artificial heating of the river by the effluent of the Early Power Station, causes earlier breeding and greater growth in the first year of life in *A. anatina*, and a longer growing season in the later years of life of *Unio pictorum*.
6. The winter rings were used to interpret the growth history of each specimen. Growth is related to the temperature during the growing season; *Anodonta anatina* and *Unio pictorum* grew best in the warm summer of 1959.
7. The best estimates of population density were obtained from grab and Surber samples. The average for a selected reach of the river was twenty-two mussels per square

metre, equivalent to a standing crop of 1208 kg/ha (wet weight, excluding shells). Mark-recapture experiments yielded less reliable results. The figures for biomass and annual production for each species are *Anodonta anatina* 648.2 kg/ha, 132.2 kg/ha; *Unio pictorum* 382.1 kg/ha, 52.9 kg/ha; *U. tumidus* 156.1 kg/ha, 20.0 kg/ha; *Anodonta minima* 20.9 kg/ha (production not estimated). The production of glochidia of *A. anatina* during 1964 was 19.9 kg/ha. The ratio of production-standing crop for all species is 1 : 6.

8. The standing crop of mussels excluding shells represents more than 90% of the biomass of the bottom fauna, and is twice that of the fish population. Only very small mussels can be eaten by fish, and the greater part of the population will be available for food for other organisms only after the mussels have died.

REFERENCES

- Borutsky, E. V. (1939). Dynamics of the total benthic biomass in the profundal of Lake Beloie. *Trudy limnol. Sta. Kosine*, **22**, 196-218.
- Chamberlain, T. K. (1931). Annual growth in freshwater mussels. *Bull. Bur. Fish., Wash.* **46**, 713-39.
- Coker, R. E., Shira, A. F., Clark, H. W. & Howard, A. D. (1921). The natural history and propagation of fresh-water mussels. *Bull. Bur. Fish., Wash.* **37**, 75-181.
- Coker, R. E. & Surber, T. (1911). A note on the metamorphosis of the mussel *Lampsilis laevissimus*. *Biol. Bull. mar. biol. Lab., Woods Hole*, **20**, 179-82.
- Comfort, A. (1957). The duration of life in molluscs. *Proc. malac. Soc. Lond.* **32**, 219-41.
- Crowley, T. E. (1957). Age determination in *Anodonta*. *J. Conch., Lond.* **24**, 201-7.
- Green, J. (1957). Growth of *Scrobicularia plana* (da Costa) in the Gwendraeth Estuary. *J. mar. biol. Ass. U.K.* **36**, 41-7.
- Haskin, H. H. (1954). Age determination in molluscs. *Trans. N. Y. Acad. Sci. Ser. II*, **16**, 300-4.
- Howard, A. D. (1921). Experiments in the culture of fresh-water mussels. *Bull. Bur. Fish., Wash.* **38**, 63-89.
- Isely, F. B. (1911). A preliminary note on the ecology of the early juvenile life of the Unionidae. *Biol. Bull. mar. biol. Lab., Woods Hole*, **20**, 77-80.
- Kuenzler, E. J. (1961). Structure and energy flow of a mussel population in a Georgia salt marsh. *Limnol. Oceanogr.* **6**, 191-204.
- Lefevre, G. & Curtis, W. C. (1910). Studies of the reproduction and artificial propagation of freshwater mussels. *Bull. Bur. Fish., Wash.* **30**, 105-201.
- Mann, K. H. (1964). The pattern of energy flow in the fish and invertebrate fauna of the River Thames. *Verh. int. Verein. theor. angew. Limnol.* **15**, 485-95.
- Mann, K. H. (1965a). Heated effluents and their effects on the invertebrate fauna of rivers. *Proc. Soc. Wat. Treat. Exam.* **14**, 45-53.
- Mann, K. H. (1965b). Energy transformations by a population of fish in the River Thames. *J. Anim. Ecol.* **34**, 253-75.
- Mason, J. (1957). Age and growth of the scallop *Pecten maximus* (L.) in Manx waters. *J. mar. biol. Ass. U.K.* **36**, 473-92.
- Ökland, J. (1963). Notes on population density, age distribution, growth and habitat of *Anodonta piscinalis* Nilss. (Moll., Lambellibr.) in a eutrophic Norwegian Lake. *Nytt Mag. Zool.* **11**, 19-43.
- Segerstråle, S. G. (1960). Investigations on Baltic populations of the bivalve *Macoma baltica* (L.). I. *Commentat. Biol.* **23** (2), 1-72.
- Weymouth, F. W. & McMillin, H. C. (1930). The relative growth and mortality of the Pacific Razor Clam (*Siliqua patula* Dixon) and their bearing on the commercial fishery. *Bull. Bur. Fish., Wash.* **46**, 543-67.
- Williams, W. P. (1965). The population density of four species of freshwater fish, roach (*Rutilus rutilus* (L.)), bleak (*Alburnus alburnus* (L.)), dace (*Leuciscus leuciscus* (L.)) and perch (*Perca fluviatilis* (L.)) in the River Thames at Reading. *J. Anim. Ecol.* **34**, 173-85.